

---

## Wireless Pneumatic Thermostat – WPT Summer/Winter Series

### 1 Overview

The Cypress Envirosystems Summer/Winter Wireless Pneumatic Thermostat (WPT) retrofits an existing pneumatic thermostat to provide Direct Digital Control (DDC) like zone control functionality at a fraction of the time and cost without disturbing occupants.

The WPT enables remote monitoring of zone temperature, branch pressure, remote control of setpoints, and programmable setback or setup of the pneumatic HVAC systems. It also enables integration with utility Demand Response programs.

The WPT can function either as a standalone system or can be integrated with an existing Building Management System via BACnet/IP. As a result, the WPT helps building owners and tenants save energy by implementing indoor temperature policies, improve comfort, and reduce the maintenance cost of the legacy pneumatic HVAC systems.

#### 1.1 Components

The WPT Series kit includes the following components:

- WPT
- Universal Wall Bracket
- Mounting screws, #6 x 1" self-tapping (x2)
- Wall Anchors
- CR123 batteries (x2)

#### 1.2 Prerequisites for Installation

The WPT relies on a wireless network for communication unless operating in a standalone mode. When using the WPT in a standalone mode, these prerequisites may be skipped. Before installing the WPT, the wireless network must be set up. The following tasks must be completed before proceeding to WPT installation:

- Installation of WPT Green Box and USB Hub (HUSB)
- Installation of WPT Repeaters (RWAL)
- Assignment of a network ID to the Green Box
- Assignment of a unique node ID to each WPT and/or WPT in the network

Manuals for the WPT Green Box, HUSB, and repeaters can be found at <http://www.cypressenvirosystems.com>.

#### 1.3 Tools Required for Installation

- # 1 Philips-head screwdriver
- 1/16" hex Allen wrench
- 3/16" Drill (for setting Wall Anchor, if required)

### 2 WPT Installation

The overall WPT installation procedure includes:

- Mounting the WPT on the wall

- Configuring the WPT
- Calibrating the WPT

## 2.1 Mounting the WPT

### 2.1.1 Remove the Existing Thermostat

1. Remove the external cover of the existing thermostat, if any.
2. Locate and remove the mounting screws and carefully remove the unit from the wall along with the attached pneumatic tubes.
3. Detach the old thermostat unit from the air tubes carefully. The air tubes may not have a lot of slack – be careful that the tubes do not retract into the wall. In a 2-pipe system, note the positions of branch and main tubes.

### ESD Handling Precautions

#### Warning!



- The WPT contains ESD sensitive circuit cards and components.
- Great care must be exercised while handling the WPT with the cover open.
- Do not touch any of the circuit boards with fingers or any part of the body.
- Touching the circuit boards may cause the unit to fail due to electrostatic discharge.
- Hold and handle the unit as shown in Figure 1, using the external bottom plastic cover as the support.

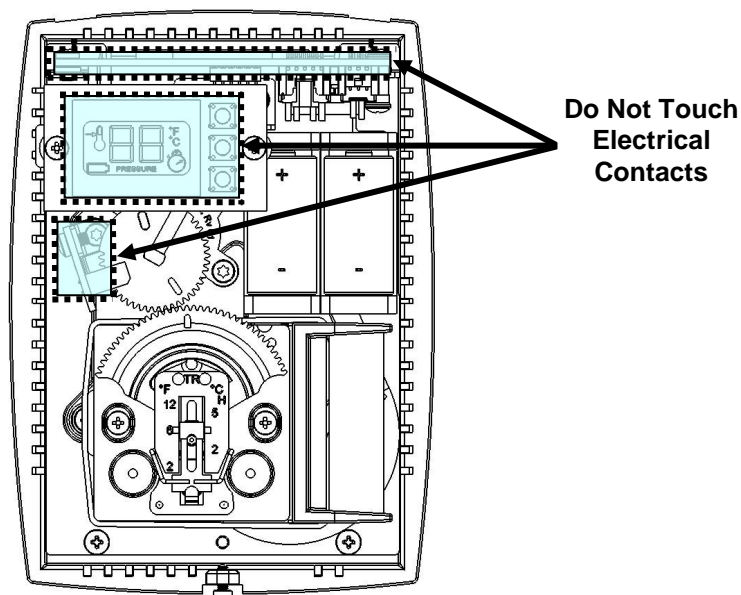
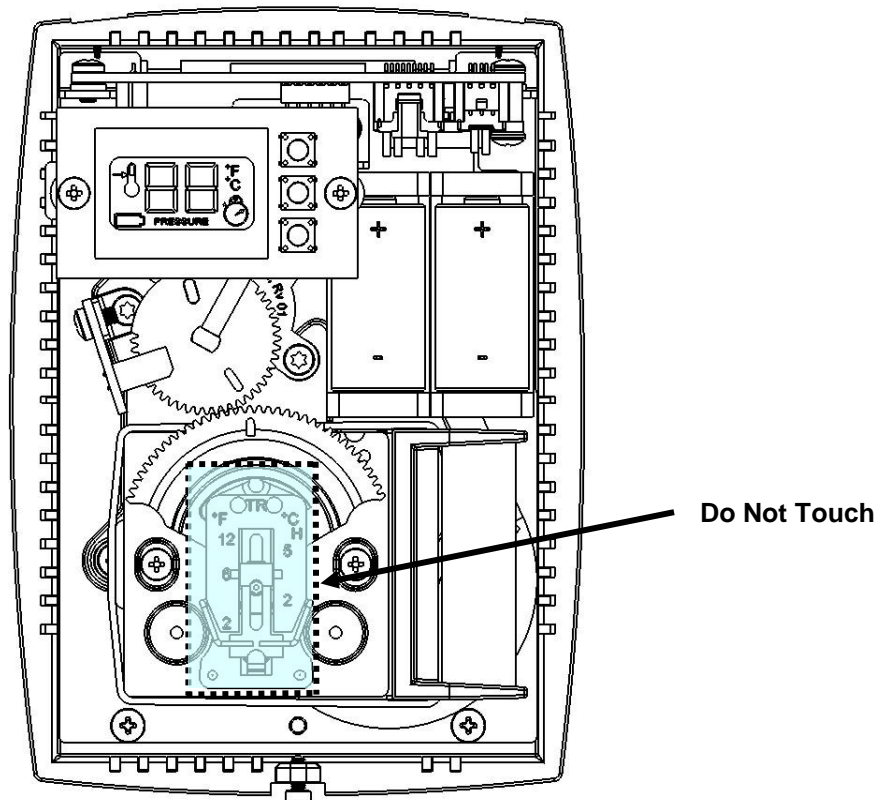

**Figure 1. Handling the WPT**

### Thermostat Handling Precautions

#### **Warning!**

- Great care must be exercised while calibrating the WPT.
- Handle the thermostat Bi-Metallic Spring (BMS) assembly as little as possible.
- Use extreme caution not to touch the BMS during calibration.
- Damage to the bi-metallic spring can result if mishandled.

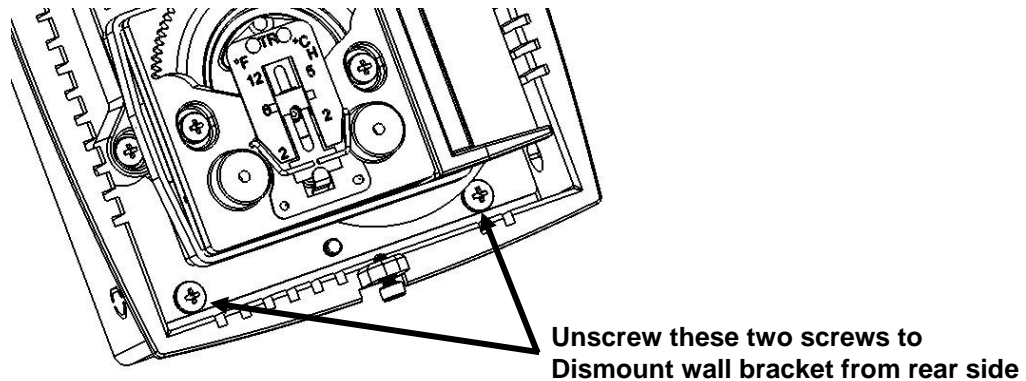

**Figure 2. WPT BMS Assembly**

#### 2.1.2 Installing the WPT

The WPT is installed in the existing thermostat location using the Universal Wall Bracket provided with the WPT kit. To install the WPT:

1. Remove the plastic cover of the WPT using a 1/16" Allen wrench on the bottom screw.
2. If the Universal Wall-mounting Bracket is attached to WPT, remove it by unscrewing the two captive screws on the bottom of the WPT, as shown in Figure 3.



**Figure 3. Removing the Universal Wall Bracket**

3. Adjust the Universal Wall Bracket against the old thermostat position, such that any two slots on the wall bracket match the existing two screw holes on the wall, and the large center opening is aligned with the air tube(s). The Universal Wall Bracket is shown in Figure 4.

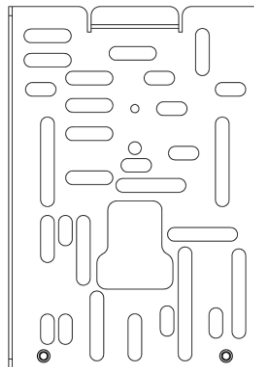
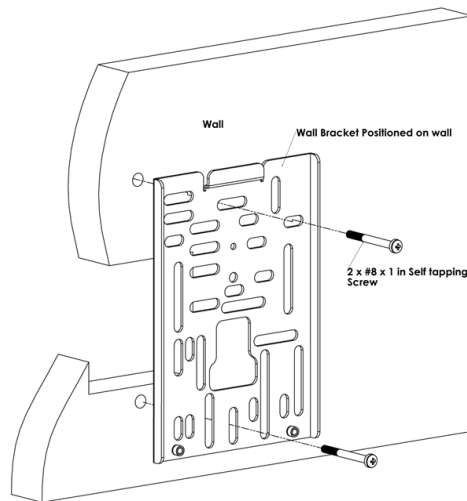

**Figure 4. Universal Wall Bracket**

4. Pull the air tubes through the central opening of the Universal Wall Bracket.
5. Affix the Universal Wall Bracket to the wall with two screws, as shown in Figure 5.

**NOTE:** Be sure not to kink the tubing as it runs to/from the thermostat tubing stub connections.

**NOTE:** The provided Wall Anchors can be used if existing receptacles are not in the correct location, or if they are damaged.



**Figure 5. Mounting the Universal Wall Bracket**

6. Connect the branch and main tubes to the air tubes marked B and M on the rear of the WPT, as shown in Figure 6. Connect the pneumatic tube to the M port in case of single pipe WPT.

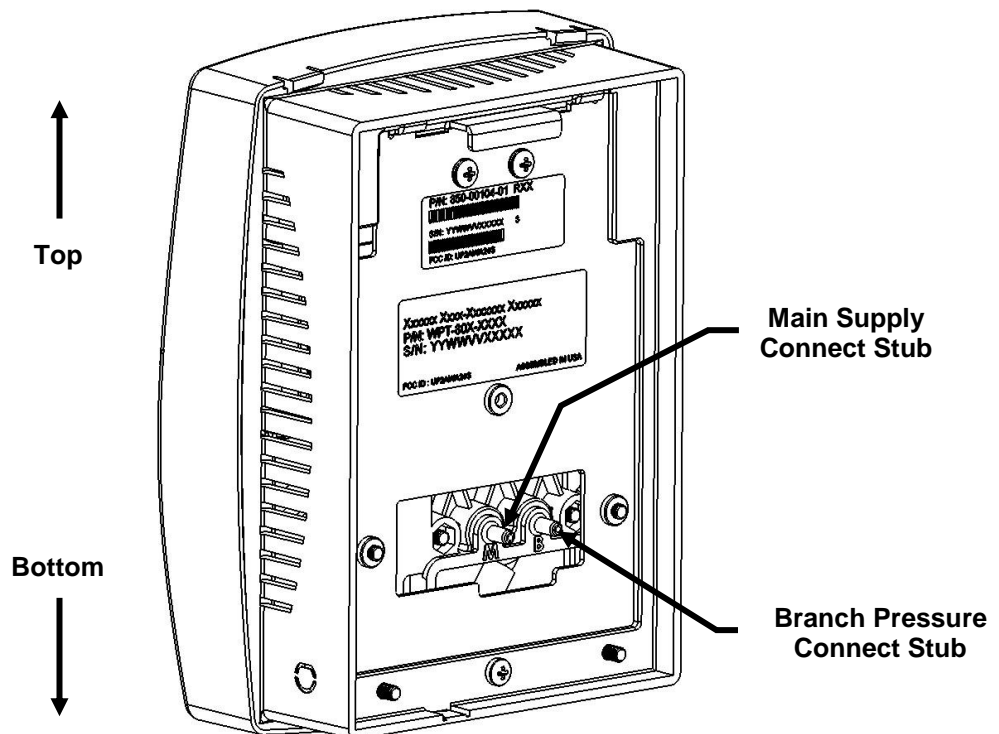

**Figure 6. Connecting Main and Branch Tubes to M and B Ports**

7. Attach the WPT to the Universal Wall Bracket using the captive screws.
8. Install the batteries and close the top cover. The battery polarities are as shown in Figure 7.

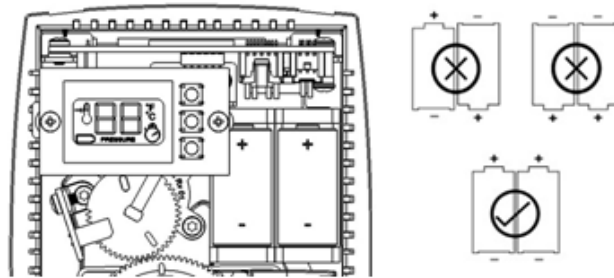

**Figure 7. WPT Batteries**

### 2.1.3 Installing/Replacing Batteries

The WPT has a battery icon on the LCD display which indicates the current state of the batteries. Batteries must be replaced anytime the battery icon displays fewer than 4 bars as shown in the images below.



When the batteries are too low to function normally, the WPT will enter a fail-safe mode until batteries are replaced. The fail-safe mode shuts down all functions of the WPT except for temperature control which continues to operate at a setpoint of 72 °F. The WPT will display the following screen during this mode.

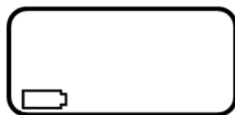

**Note:** With older generation WPT thermostats, the device may go directly to a blank display and/or stop responding to button presses.

The following tasks must be performed after replacing batteries:



- Press any button to power on the WPT.
- Perform a Force Discovery. Refer to Figure 8 for the menu structure.
- Perform a manual calibration, see section 2.3.
- (Optional) Resend temperature setpoints, setpoint limits and auto calibration values from the WPT Green Box Controller. Refer to the appropriate WPT Green Box manual for instructions.

**NOTE:** If any of the steps above fail, refer to the Additional Troubleshooting section at the end of this manual for further details.

#### 2.1.4 Battery Handling Precautions

 **Warning!**

Replace battery with Type CR123A that meet UL-1642, as evidenced by UL component recognition mark, only (from Panasonic, Energizer or Duracell). Use of any other battery may present a risk of fire or explosion. See Figure 7 for correct polarity.

- Underwriters Laboratories Recognition Mark: 
- Caution: The battery used in this device may present a fire or chemical burn hazard if mis-treated. Keep away from children and/or other untrained personnel. Do not recharge, disassemble, heat above 100 °C (212 °F), or dispose of in fire.
- Dispose of used battery promptly in accordance with local regulations (place in plastic bag and recycle if possible).
- Do not insert batteries with the  and  polarities reversed.
- Do not short-circuit.
- Be sure to wrap each battery when disposing or storing to avoid short circuit.

 **Caution!**

- If leaked liquid gets in the eyes, wash them with clean water and consult a physician immediately.
- Do not use new and used batteries together. Do not use different types of batteries together.
- Do not apply strong pressure to the batteries nor handle roughly.
- Do not use or leave the batteries in direct sunlight or in high-temperature areas.

#### 2.2 Configuring the WPT

**NOTE:** When installing the WPT in a standalone mode, please skip to Section 2.2.4.

The WPT can be configured using the LCD display and the 3 front buttons. The menu structure is displayed below. Please refer to this diagram while calibrating and configuring the WPT.

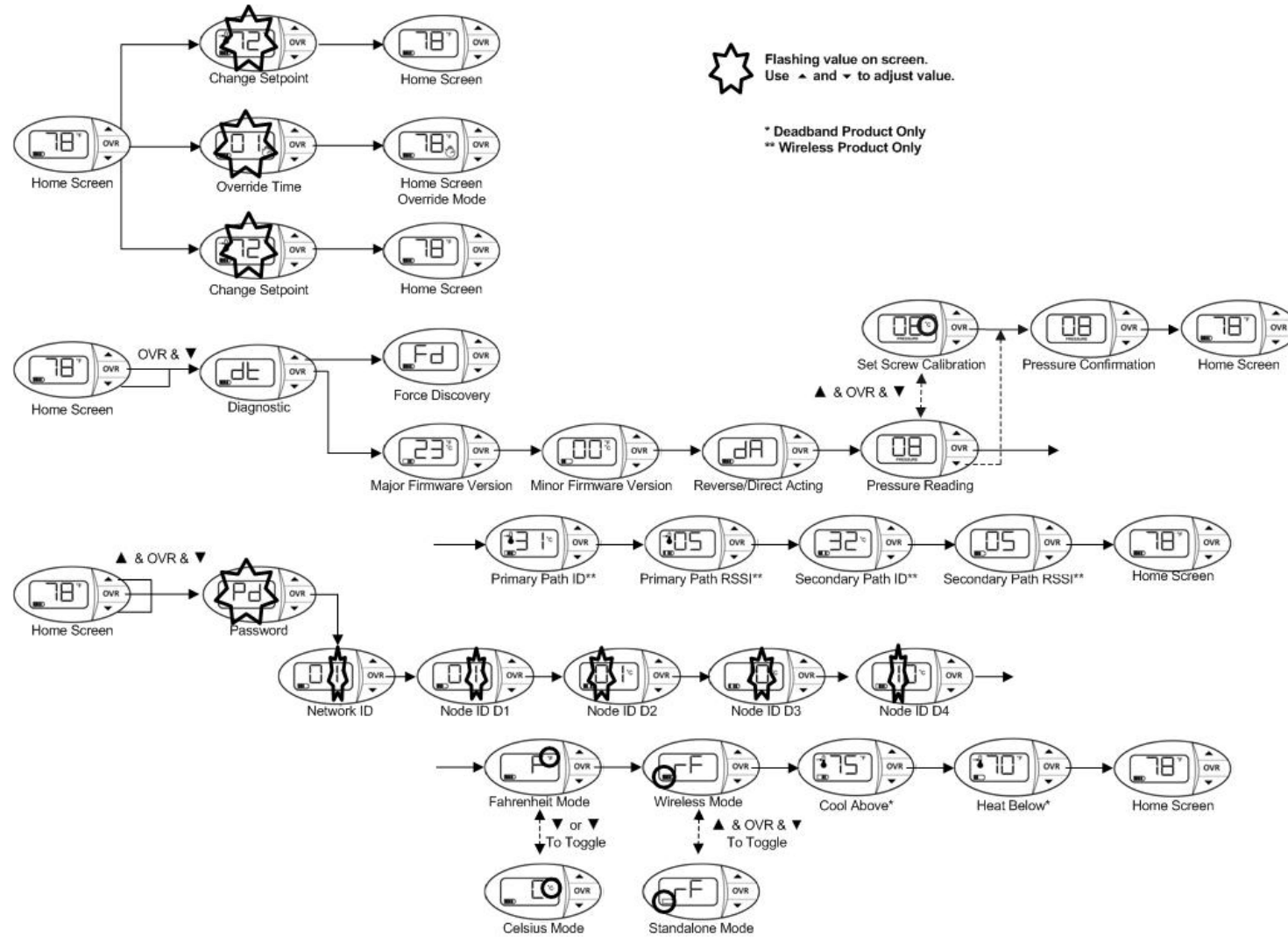

**Figure 8. WPT Menu Structure**



### 2.2.1 Programming Mode Password

A password is required to enter the Programming Mode. After pressing all three buttons simultaneously, the following screen will appear:



The password is a series of button presses: “C

For passwords, contact  
 Cypress Envirosystems

### 2.2.2 Configuring the Network ID and Node ID

The WPT must be configured with a valid network ID and node ID for the unit to be operational. The network ID is a single digit number. The node ID is a four-digit number. The four digit node ID is displayed in groups of two (D2, D1 together and D4, D3 together).



**Figure 9. WPT Node ID Digits**

Before programming the WPT, insert the batteries in the holder and press any button. The system will turn on and initialize. During initialization and whenever the WPT starts a discovery process, “dy” is displayed on the LCD. During this period, the WPT is attempting to discover its nearest RWALS and HUSB. This process should not be disturbed. Wait for the “dy” to disappear from the LCD before performing any additional operations. After initialization, the LCD displays either E0 or the current temperature. See troubleshooting section for a description of display codes. The WPT is now ready for the configuration of the network ID and the node ID.

To configure the network ID and the node IDs, perform the following:

1. Press all three buttons simultaneously, then release. The WPT enters “Programming Mode” and requires a password to continue (see section 2.2.1). After the password is successfully entered, the screen will show the current or default network ID.

**NOTE:** °F icon is displayed, indicating that the network ID is being programmed.

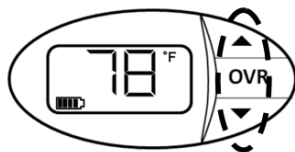

**Press and release all three buttons simultaneously to enter Programming Mode**

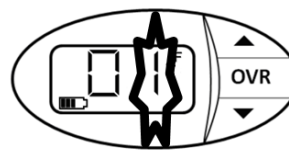

**After entering a correct password, the Network ID will flash signifying Programming Mode**

**Figure 10. Configuring Network ID**

2. Press the ▲ or ▼ button to change the network ID to the required value.  
**NOTE:** The network ID cannot have a “0” value.
3. Press OVR to confirm the network ID. This completes the programming of the network ID and the LCD displays the first digit, D1, of the node ID.  
**NOTE:** °C icon is displayed, indicating that the node ID is being programmed.
4. Press the ▲ or ▼ button to change D1 to the required value.
5. Press OVR to confirm D1.
6. Repeat steps 4 and 5 to configure D2, D3, and D4 of the node ID.  
**NOTE:** While the node ID is being configured, the corresponding bar of the battery indicator flashes.  
**NOTE:** D1 and D4 cannot have a “0” value.

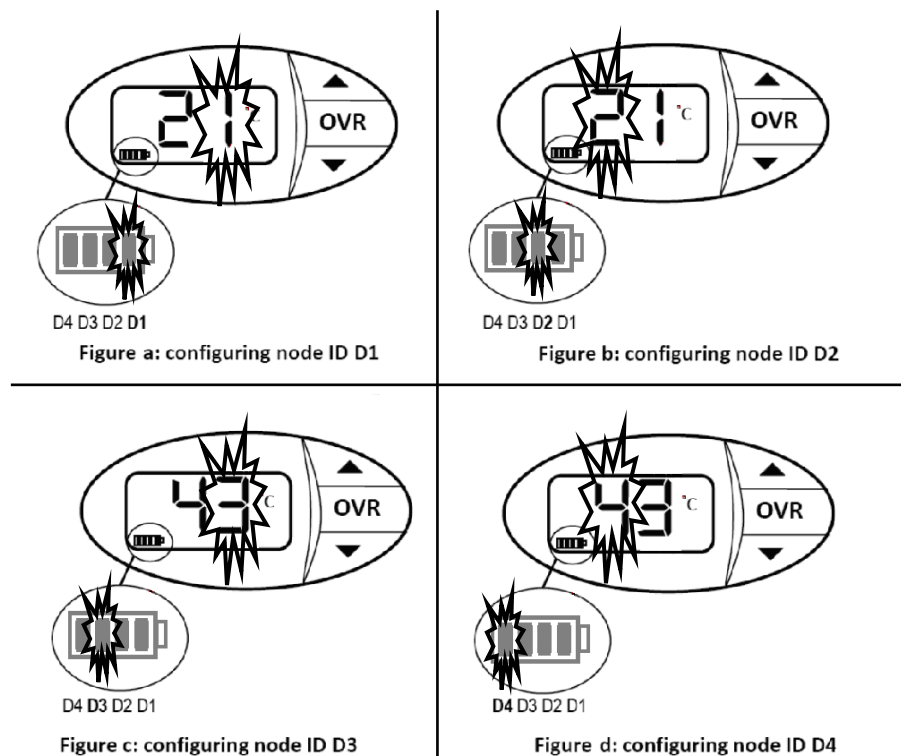

**Figure 11. Configuring Node ID 4321**

7. After D4 is configured and confirmed, continue to press OVR to exit the Programming Mode.  
**NOTE:** The WPT will automatically exit the Programming Mode if no button is pressed for one minute.

The network and node IDs can be changed any time by completing steps 1 through 7.

### 2.2.3 Selecting between Celsius and Fahrenheit display

The WPT can display temperatures in Celsius or Fahrenheit. The default setting is for Fahrenheit. To toggle the setting:

1. From the home screen, press all three buttons simultaneously to enter “Programming Mode” and enter the password (see section 2.2.1 ).
2. Press the OVR button 5 times to navigate past the Network and Node ID programming screen and into the Celsius/Fahrenheit screen.
3. Press ▲ or ▼ to toggle between Celsius and Fahrenheit.
4. Press OVR to accept the C/F change.
5. Continue to press OVR to exit Programming Mode.
6. Verify that the ambient temperature is displayed in the selected units (C or F).

### 2.2.4 Standalone (RF Mode) On/Off

The WPT can also be used as a standalone pneumatic thermostat. In this setup, the wireless radio is turned off to preserve battery life. If the radio remains on without a wireless network, the WPT will continually search for a network, which reduces the overall battery life. To turn off the radio, perform the following:

1. From the home screen, press all three buttons simultaneously to enter “Programming Mode” and enter the password (see section 2.2.1 ).
2. Press the OVR button 6 times to navigate past the Network, Node ID, and the C/F screen into the Standalone On/Off screen.
3. Press all three buttons simultaneously to toggle between Standalone (RF Mode) On and Off. In this menu, when the battery icon is empty, RF is off and the device is in standalone mode. When the battery icon is full, RF is on and the device requires a Wireless Network.
4. Press OVR to accept the Standalone changes.

**NOTE:** The Occupancy state of a WPT in Standalone is always “Occupied”. Occupancy Override will not be available, see section 3.2.

## 2.3 Calibrating Summer-Winter WPT

1. Remove the front cover of the WPT and make sure that the WPT is acclimatized to the ambient temperature. Use 1/16” Allen drive to loosen screw at bottom of cover; because the cover has a key slot, the screw does not have to be fully removed.

**NOTE:** Acclimatization can take 5 to 10 minutes after attachment to the wall. The Bi-Metallic Spring (BMS) is very sensitive to body heat. Keep hands and breathe away from the BMS to minimize calibration error.

**NOTE:** The copper colored Throttling Range (TR) adjuster has been factory set at 6 °F as shown in Figure 13. The factory setting provides a Throttling Range (TR) of 2-1/2 psi/°F. The TR adjuster **SHOULD NOT BE MOVED** in order to ensure proper operation and accuracy of the WPT.

### 2.3.1 Setting Switch-Over pressure

1. Adjust the Main Supply pressure regulator to desired Switch-Over Pressure. See Table 1 for typical manufacturer’s calibration settings.

2. For RA/DA stats (RA at Low Main Supply, DA at High Main Supply), set control temperature setting to 85 °F. For DA/RA stats (DA at Low Main Supply, RA at High Main Supply), set control temperature setting to 55 °F. Verify cam gear is at furthest clockwise position before proceeding to next step (branch pressure should now be very close to main supply pressure).
3. Use 1/16" Allen drive to carefully adjust the Switch-Over Pressure Calibration Screw until the indicated Branch Pressure just drops to 0 psig. This sets the switch-over pressure snap action point.

**NOTE: Turning screw clockwise will eventually cause Branch Pressure to drop.**

**NOTE: The switch-over point adjustment requires changes to the Main Supply air pressure, which could affect other parts of the system. This adjustment should instead be made on a test bench where an adjustable Main Supply Pressure is available**

**NOTE:** To verify (or fine tune) the switch over pressure: Reduce Main Supply pressure to 2 psig below desired switch point, then increase slowly to note when Branch Pressure increases (i.e. Branch Pressure increases at the instant the Main Supply reaches the switch over pressure). Repeat steps 1, 2 & 3 above as needed to achieve desired switch over pressure.

### 2.3.2 Enter WPT Calibration Mode

1. To enter Calibration Mode, perform the following:
2. Press the ▼ button and OVR (Center) button together for two seconds. The display will show 'dt'.
3. Press the OVR (Center) button four times. The LCD displays the branch pressure in PSI along with PRESSURE indicator. The display shows "--" if the motor is in motion when trying to access branch pressure.
4. Press all three buttons simultaneously to enter Calibration Mode. The "C" icon will flash rapidly while in this mode
5. The WPT will exit Calibration Mode after three minutes. Another way to exit Calibration Mode is to press the **OVR** (Center) button. If the WPT exits Calibration Mode before you are done simply repeat steps 1 through 3 to re-enter Calibration Mode.

**NOTE: Explanation of Calibration Mode:**

The control electronics receives data from the WPT's thermal sensor and adjusts the position of the setpoint cam. This cam movement adjustment is much finer than can be done in manual mode and is the best way to achieve an accurate calibration.



**Figure 12. Pressure Display Resolution**

**NOTE:** Each battery segment on the LCD represents 0.25 PSI resolution, as shown in Figure 12. Pay special attention to this extra resolution while turning the set screw. It is critical this value precisely matches the control point for seamless operation

### 2.3.3 Calibrate Branch Pressures for Low and High Main Supply Modes

1. After Switch-Over Pressure is confirmed correct, set Main Supply regulator pressure to ~ 2 psig below the Switch-Over pressure (to ensure thermostat is in Low Main Supply pressure Action Mode), then use 1/16" hex drive to adjust the "Branch Pressure Calibration Screw (Low)" to desired control pressure (typically 8 psig, but can be as high as 12 psig). Adjustment is sensitive and should require less than 1/8 turn to go from a control pressure of 8 psig to 12 psig.

**NOTE: Use extreme care when inserting the 1/16" hex drive through the opening in the BMS to the calibration screw. The BMS can be very easily damaged by a misplaced tool movement. Use care not to breathe on BMS during calibration. Heat from hands or breath will affect calibration accuracy.**

**NOTE: The Low Main Supply Pressure calibration must be performed first to achieve proper calibration in both modes.**

**NOTE: Turning the Branch Pressure Calibration Screw (Low) clockwise will increase the Branch Pressure (counter-clockwise rotation will decrease Branch Pressure)**

**NOTE: Refer to Figure 13 for locations of the three Calibration Screws.**

2. Re-set Main Supply pressure to ~ 2 psig above the Switch-Over pressure (to ensure thermostat is in High Main Supply pressure Action Mode), then use 1/16" hex drive to adjust the Branch Pressure Calibration Screw (High) to desired control pressure (typically 8 psig, but can be as high as 12 psig). Adjustment is very sensitive and should require less than 3/4 turn to go from a control pressure of 8 psig to 12 psig.

**NOTE: Turning the Branch Pressure Calibration Screw (High) clockwise will reduce the Branch Pressure (counter-clockwise rotation increases Branch Pressure)**

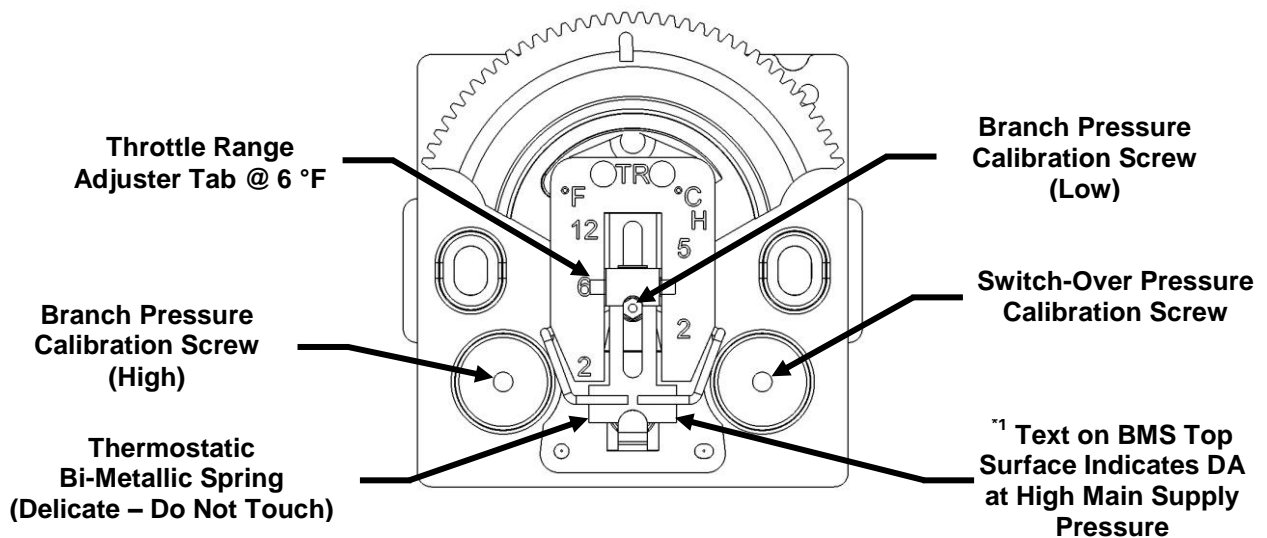

**Figure 13. WPT Calibration Screw Locations**

3. When the desired control pressure is achieved, press the OVR (Center) button to exit Calibration mode and save the value.
4. A confirmation screen will appear and flash the stored control pressure for 3 seconds. Repeat the calibration procedure if this value does not match the desired control pressure.

**NOTE: The WPT will automatically exit Calibration Mode if OVR is not pressed after 3 minutes. The control pressure will NOT be saved and the WPT will return to the home screen**

5. Replace the WPT front cover.

**\*1 NOTE: No text on BMS Top Surface indicates Reverse Acting at High Main Supply Pressure**

Brand	Model No	Action <sup>*2</sup>		Switch-Over <sup>*3</sup>	Calibration
		High (psig)	Low (psig)	Pressure (psig)	Point (psig)
Barber-Colman	TK-1731	DA – 20	RA – 15	17.5	8
	TK-1741	RA – 20	DA – 15	17.5	8
Honeywell	TP972A2002	DA – 18	RA – 13	15.5	8
Johnson	T-4756-201	RA – 20	DA – 15	17.0	8, or mid spring range of controlled device
	T-4756-202	RA – 20	DA – 15	17.0	
	T-4756-205	DA – 20	RA – 15	17.0	
	T-4756-206	DA – 20	RA – 15	17.0	
Robertshaw (or TAC, or Schneider-Electric)	2218-132	DA – 25	RA – 16	20.5	12
	2218-133	RA – 25	DA – 16	20.5	12
	2218-134	DA – 18	RA – 13	15.5	12
	2218-301	DA – 25	RA – 16	20.5	9
Powers	192-209	DA – 25	RA – 18	20.5	7.5
	192-208	RA – 25	DA – 18	20.5	7.5

**Table 1. Model Comparison / Function Matrix**

- \*1 - Direct Acting is defined as Branch Pressure increasing the more the ambient temperature rises above set-point (a Direct Acting thermostat will increase branch pressure when the BMS is warmed by breathing on it); Reverse Acting is defined as Branch Pressure decreasing the more the ambient temperature rises above set-point (a Reverse Acting thermostat will decrease branch pressure when the BMS is warmed by breathing on it).
- \*2 - Main Supply Pressure “High” is above switch-over pressure; Main Supply Pressure “Low” is below switch-over pressure
- \*3 - Switch-over pressure is the main supply pressure at which the thermostat changes its thermal response action from Direct Acting to Reverse Acting, or from Reverse Acting to Direct Acting.
- \*4 - Winter mode is typically considered Direct Acting (at High Main Supply Pressure) and summer mode is considered Reverse Acting (at Low Main Supply Pressure).

### 3 Operation

The various indicators and characters that are displayed on the LCD display are shown in the Figure 14.

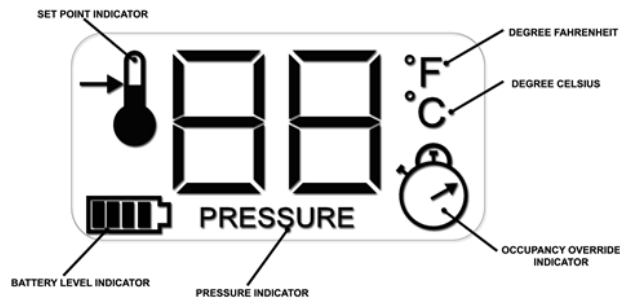

**Figure 14. LCD Display**

The front panel of the LCD display is used to perform the following functions:

- Adjusting the setpoint temperature
- Turning on/off the occupancy override
- Measuring the branch line pressure

#### 3.1 Adjusting the Setpoint Temperature

The setpoint temperature may be shifted up or down using the ▲ or ▼ buttons. To change the setpoint temperature:

- Press the ▲ or ▼ button once to view the current setpoint along with the setpoint indicator.
- Press the ▲ or ▼ button to change the setpoint value.
- Once the desired value is reached, press the OVR button to accept the change. Leaving the display on the desired value for 5 seconds will also result in a setpoint change.

The LCD display will revert to the current temperature.

#### 3.2 Turning ON/OFF the Occupancy Override

**NOTE:** This feature only works if the WPT is in “Unoccupied” mode as commanded by the scheduler.

To change the occupancy state from “Unoccupied” to “Override”:

- Press the OVR button to activate the occupancy override. The LCD display flashes the override duration in hours.
- Press the ▲ or ▼ button to change the override duration to desired value.
- Once the desired value is reached, press the OVR button to accept the change. Leaving the display on the desired value for 5 seconds will also result in a duration change.

During Occupancy Override, the setpoint will revert to the last “Occupied” value as commanded by the server. During the override duration, the LCD displays the OVR indicator.

### **3.3 Measuring the Branch Line Pressure**

To measure the branch line pressure:

- Press the ▼ button and OVR button together for two seconds.  
**NOTE:** The display shows ‘dt’.
- Press OVR four times. The LCD displays the branch pressure in PSI along with PRESSURE indicator. **NOTE:** The display shows “--” if the motor is in motion when trying to access branch pressure. Press OVR to exit and try again.
- Press OVR to exit.

### **3.4 Checking the Control Pressure**

Follow these steps to verify the control pressure:

- Press the ▼ button and OVR button together for two seconds.  
**NOTE:** The display shows ‘dt’.
- Press OVR four times. The LCD displays the branch pressure in PSI along with PRESSURE indicator. **NOTE:** The display shows “--” if the motor is in motion when trying to access branch pressure. Press OVR to exit and try again.
- Press the ▼ button. The LCD will flash the stored control pressure for 3 seconds and return to the home screen. The battery segments on the LCD represent 0.25 PSI resolution.

### **3.5 Locking and Unlocking WPT Controls**

The WPT can be locked to prevent occupants from overriding setpoints. To lock or unlock the WPT, press the ▲ and ▼ buttons simultaneously. The display will show “LC” if the unit is locked, “UL” if the unit is unlocked. Press the ▲ and ▼ buttons simultaneously to reach the desired condition.



### 3.6 Checking Signal Strength

Each WPT attempts to find a primary and secondary wireless path back to the HUB. The paths and associated signal strengths (1-5) from the WPT are displayed in the “dt” menu.

**NOTE:** This menu is not available in Standalone mode.

- Press the ▼ button and OVR button together for two seconds. The display will show ‘dt’
- Press the OVR button 5 times to see the primary path. °C icon is displayed, indicating that the ID is being displayed (either a repeater ID or the HUB ID).
- Press the OVR button again to see the wireless signal strength from the WPT to the primary path.
- Press the OVR button again to see the secondary path. °C icon is displayed, indicating that the ID is being displayed (either a repeater ID or the HUB ID).
- Press the OVR button again to see the wireless signal strength from the WPT to the secondary path.

**NOTE:** The Set Point Icon will identify the path currently in use by WPT as shown in Figure 15.

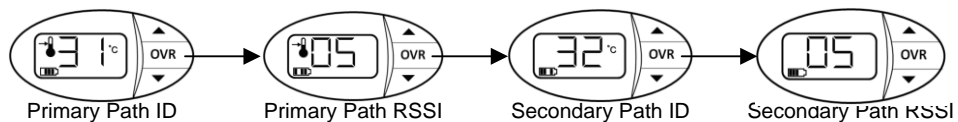

**Figure 15. Primary and Secondary Path Signal Strengths**



## Troubleshooting

The WPT is designed with diagnostic functions to detect and diagnose faults.

Code	Reason	Solution
dy	<u>Discovery Status:</u> This code indicates that the WPT is performing a discovery operation and it should not be disturbed.	<ul style="list-style-type: none"> <li>This indication disappears automatically after a few seconds.</li> </ul>
dt	<u>Diagnostic Status:</u> This code indicates that the WPT is performing a diagnostic operation.	<ul style="list-style-type: none"> <li>This indication disappears automatically after a few seconds.</li> </ul>
Fd	<u>Force Discovery:</u> This code indicates that the WPT is performing a force discovery operation.	<ul style="list-style-type: none"> <li>This indication disappears automatically after a few seconds.</li> </ul>
UL	<u>Keypad Unlocked:</u> Indicates that the buttons were unlocked by the user.	<ul style="list-style-type: none"> <li>This indication disappears automatically after a few seconds.</li> </ul>
LC	<u>Keypad Locked:</u> Indicates that the buttons are locked.	<ul style="list-style-type: none"> <li>This indication disappears automatically after a few seconds.</li> </ul>
E0	<u>Discovery Error:</u> Not able to connect to the nearest RWAL or HUSB.	<ul style="list-style-type: none"> <li>Perform Force Discovery to retry (see Figure 8).</li> <li>Verify the Network ID has been properly configured in the WPT.</li> <li>Verify nearby RWALS and the HUSB are connected and working properly.</li> <li>If the error persists, nearby RWALS or the HUSB must be relocated. If this is not feasible, an additional RWAL must be installed.</li> <li>This error disappears automatically within 15 minutes or by any button press.</li> </ul>
E1	<u>Time Synchronization Error:</u> Not able to synchronize the WPT time with the wireless network.	<ul style="list-style-type: none"> <li>The WPT automatically recovers from this error after a few refresh cycles.</li> </ul>
E2	<u>Radio Error:</u> Not able to send/receive data.	<ul style="list-style-type: none"> <li>If the error persists, contact the original distributor for replacement.</li> </ul>
E4	<u>Optical Sensor Error:</u> Not able to properly position the motor/cam.	<ul style="list-style-type: none"> <li>This error is an indication of a defective device. Contact the original distributor for replacement.</li> </ul>

### Additional Troubleshooting

Symptoms	Possible Solution
<p>The WPT does not seem to build branch pressure.</p>	<p>For 2 pipe WPTs:</p> <ol style="list-style-type: none"> <li>1. Remove the WPT from the Universal Wall Bracket.</li> <li>2. Verify both main and branch lines are connected correctly. If they are not attached correctly, reattach the line and check the pressure again.</li> <li>3. Verify that the lines are not kinked or pinched when the WPT is attached.</li> <li>4. Remove the main line and verify that air is coming out. If possible, measure the main pressure – this requires an additional pressure gauge (not provided by Cypress) connected to the main line.</li> <li>5. Reconnect the main and remove the branch line connection.</li> <li>6. Cover the branch port on the WPT completely with a finger.</li> <li>7. Adjust the setpoint so it is at least 5 degrees above the ambient temperature (for a direct acting stat) or 5 degrees below the ambient temperature (for a reverse acting stat).</li> <li>8. Check the branch pressure as described in section 3.3</li> <li>9. If the pressure in the WPT is the same as the main pressure, then there is a potential leak somewhere in the branch line and there is nothing wrong with the WPT.</li> <li>10. If the pressure in the WPT is not the same as the main pressure, try swapping the WPT with another unit.</li> </ol> <p>For 1 pipe WPTs:</p> <ol style="list-style-type: none"> <li>1. Remove the WPT from the Universal Wall Bracket.</li> <li>2. Verify that the branch line is connected correctly. If it is not connected correctly, reattach the branch line and check the pressure again.</li> <li>3. Remove the branch line and verify that air is coming out. If possible, measure the pressure – this requires an additional pressure gauge (not provided by Cypress) connected to the line. The pressure should build up to the main pressure. Keep in mind that this may take a few minutes depending on the length of tubing.</li> <li>4. If the pressure does not build up, then there is a leak in the branch line.</li> <li>5. If the pressure does build up correctly, then try swapping the WPT with another unit.</li> </ol>
<p>The WPT does not seem to be controlling correctly and/or is making a loud hissing sound</p>	<ol style="list-style-type: none"> <li>1. Check to see that the main and branch lines are connected properly to the WPT. Refer to Figure 6 for proper connection.</li> <li>2. If the lines are not properly connected, reattach the lines and check the system again.</li> <li>3. If the lines are properly connected, try swapping the WPT with another unit.</li> <li>4. If the branch and main lines are swapped, the WPT was installed incorrectly and may be damaged.</li> </ol>
<p>The WPT exhibits incorrect or suspect behavior after battery replacement, perform</p>	<ol style="list-style-type: none"> <li>1. Remove both batteries from the WPT thermostat.</li> <li>2. Press and hold the OVR button until the segments on the LCD are no longer visible.</li> <li>3. Let the thermostat sit for 30-45 minutes to fully discharge all</li> </ol>

<p>the following steps.</p> <p><i>Examples of such behavior could be: non-responsive buttons, erroneous setpoint limits, inaccurate ambient temperature or excessive motor movement.</i></p>	<p>components. This will default many of the operating parameters of the thermostat to factory defaults.</p> <p>4. Re-install the batteries and follow the steps in section 2.1.3.</p>
--	--

## 4 Repair

Except for the batteries, the WPT does not have any field replaceable or repairable parts. Contact the original distributor of the unit for repair or warranty service.

**NOTE:** Care should be taken to keep the unit dust-free during installation.

The WPT is designed to work reliably with a clean, dry-compressed air supply at the required pressure.

## 5 Technical Specification

Action	Direct Acting at High Pressure, Reverse Acting at Low pressure
Number of pipes	Two pipe
Setpoint Temperature Range	55°F to 85°F (13°C to 29°C)
Air connections	3/32 in (2.5 mm) ID tube fittings
Maximum Operating Pipe Pressure	25 psi (170 kPa)
Airflow Usage	31.1 scim @ 16 psig, 43.2 scim @ 25 psig
Sensitivity	Factory Adjusted to 2.0 – 2.5 PSI/F
Operating Frequency Band	2.4 GHz ISM Band
Battery Life	More than 2 years (with four setpoint changes per day)
Operating Conditions	32 to 122°F (0 to 50°C) 95%RH Max, Noncondensing
Storage Conditions	-40 to 122°F (-40 to 50°C) 95%RH Max, Noncondensing
Dimensions	Length: 5.6 in (141 mm ) Width: 4.1 in (104 mm ) Depth: 2.1 in (53 mm )

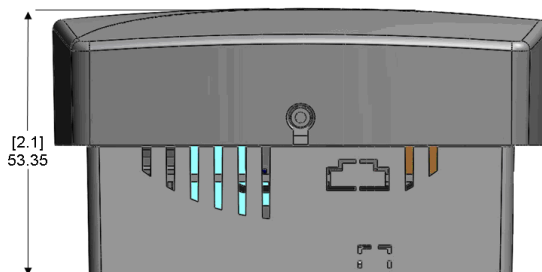
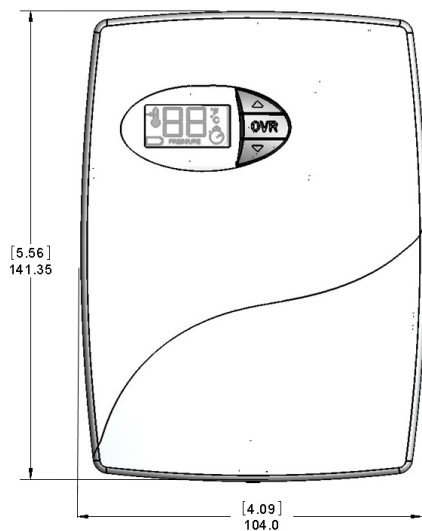

**Cypress Envirosystems**

5883 Rue Ferrari  
Suite 100  
San Jose, CA 95138  
support@cypressenvirosystems.com